

Pufferspeicher
Buffer storage tanks
Ballon tampon
Accumulatori tampone
PSM 200 – 600

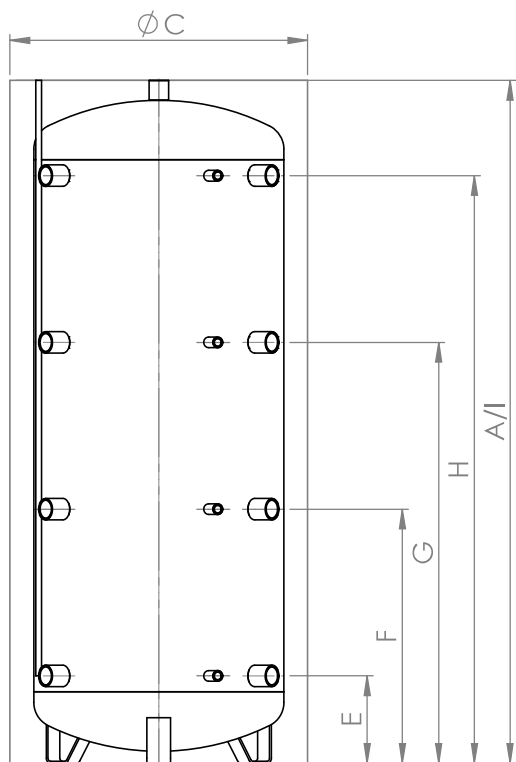

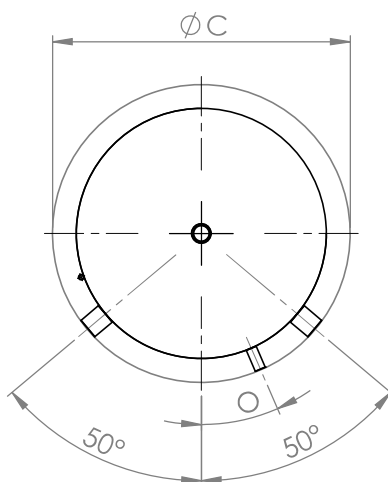





200 – 600



200 – 600



200 – 600

	Verwendung Usage Utilisation Uso	Dimension Dimension Dimension Dimensione	200	300	500	600
	Inhalt Capacity Contenance Contenuto	l	190	282	479	559
	Kippmass Tilted dimension Cote de basculement Altezza in raddrizzamento	mm	1360	1600	1880	2120
A	Höhe mit Isolierung Height with insulation Hauteur avec isolation Altezza con isolamento	mm	1215	1450	1720	1980
C	Ø mit Isolierung with insulation avec isolation con isolamento	mm	600	650	750	750
E*	Anschluss 1 Connection Raccord Collegamento	 - mm	220	220	220	220
		G"	1 ½"	1 ½"	1 ½"	1 ½"
		 - G"	½"	½"	½"	½"
F*	Anschluss 2 Connection Raccord Collegamento	 - mm	480	550	640	730
		G"	1 ½"	1 ½"	1 ½"	1 ½"
		 - G"	½"	½"	½"	½"
G*	Anschluss 3 Connection Raccord Collegamento	 - mm	740	880	1060	1230
		G"	1 ½"	1 ½"	1 ½"	1 ½"
		 - G"	½"	½"	½"	½"
H*	Anschluss 4 Connection Raccord Collegamento	 - mm	1000	1210	1480	1740
		G"	1 ½"	1 ½"	1 ½"	1 ½"
		 - G"	½"	½"	½"	½"
I	Anschluss oben Connection above Raccord du haut Collegamento superiore	 - mm	1215	1450	1720	1980
		G"	1 ¼"	1 ¼"	1 ¼"	1 ¼"
O	Anordnung Fühler Positioning sensor Disposition sonde Disposizione sensore	°	15,0	18,5	23,5	23,5
Isolierung Insulation Isolation Isolamento			60 mm fix eingeschäumt Fixed with foam Enrobage mousse fixe Schiuma rigida fissa			
	Wärmeverlust Heat losses Pertes thermiques Perdita di calore	kWh/24h	0,98	1,40	1,89	2,03
	ErP-Klasse ErP class Classe ErP Classe ErP		A	B	B	B
	Gewicht Weight Poids Peso	kg	46	60	83	91
	Art.Nr. 200103... Part no. Réf. Art.n.		0200	0300	0500	0600
	Elektroheizung zum Einschrauben* Screw-in Immersion heater* Résistances à visser* Resistenza elettrica da avvitare*	bis kW to à a	3,0	4,5	6,0	7,5

*Einbaumöglichkeit: 1 x Elektroheizung zum Einschrauben
Installation option: 1 x Screw-in Immersion heater | Option d'installation: 1 x Résistances à visser | Opzione di installazione: 1 x Resistenza elettrica da avvitare