

Pufferspeicher
Buffer storage tanks
Ballon tampon
Accumulatori tampone
PSRR 500 – 600

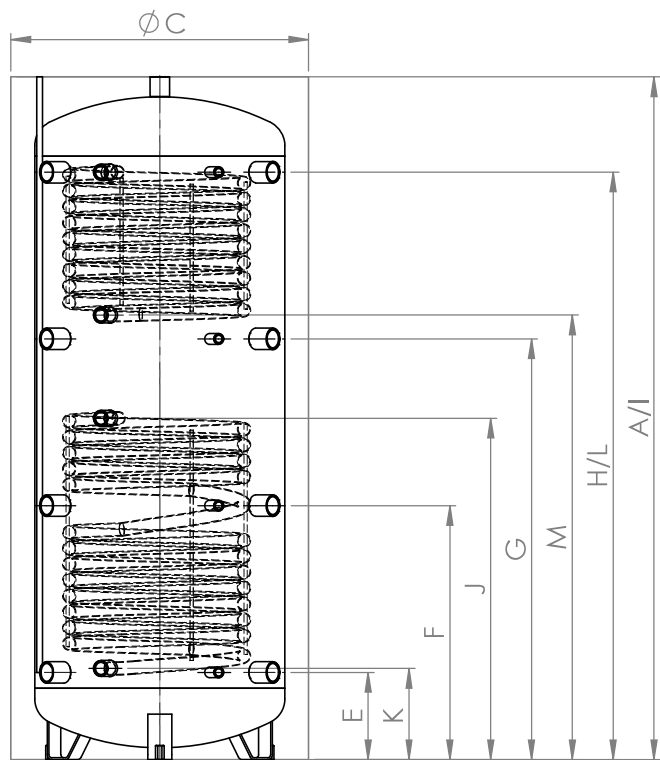

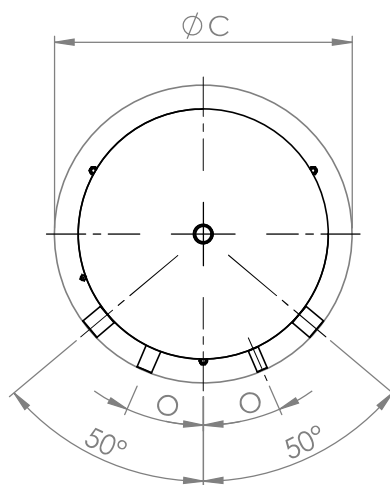









500 – 600



500 – 600



500 – 600

	Verwendung Usage Utilisation Uso	Dimension Dimension Dimension Dimensione	500	600
	Inhalt Capacity Contenance Contenuto	l	479	559
	Glattrohrwärmetauscher unten Bottom heating coil Échangeurs de chaleur bas Serpentino inferiore	m ²	1,9	1,9
		l	12,5	12,5
	Glattrohrwärmetauscher oben Top heating coil Échangeurs de chaleur haut Serpentino superiore	m ²	1,4	1,4
		l	9,2	9,2
	Kippmass Tilted dimension Cote de basculement Altezza in raddrizzamento	mm	1880	2120
A	Höhe mit Isolierung Height with insulation Hauteur avec isolation Altezza con isolamento	mm	1720	1980
C	Ø mit Isolierung with insulation avec isolation con isolamento	mm	750	750
E*	Anschluss 1 Connection Raccord Collegamento	 – mm	220	220
		G"	1 ½"	1 ½"
		 – G"	½"	½"
F*	Anschluss 2 Connection Raccord Collegamento	 – mm	640	730
		G"	1 ½"	1 ½"
		 – G"	½"	½"
G*	Anschluss 3 Connection Raccord Collegamento	 – mm	1060	1230
		G"	1 ½"	1 ½"
		 – G"	½"	½"
H*	Anschluss 4 Connection Raccord Collegamento	 – mm	1480	1740
		G"	1 ½"	1 ½"
		 – G"	½"	½"
I	Anschluss oben Connection above Raccord du haut Collegamento superiore	 – mm	1720	1980
		G"	1 ¼"	1 ¼"
J	VL Glattrohrwärmetauscher unten Bottom heating coil Échangeurs de chaleur bas Serpentino inferiore	 – mm	860	950
		G"	1"	1"
K	RL Glattrohrwärmetauscher unten Bottom heating coil Échangeurs de chaleur bas Serpentino inferiore	 – mm	230	320
		G"	1"	1"
L	VL Glattrohrwärmetauscher oben Top heating coil Échangeurs de chaleur haut Serpentino superiore	 – mm	1480	1740
		G"	1"	1"
M	RL Glattrohrwärmetauscher oben Top heating coil Échangeurs de chaleur haut Serpentino superiore	 – mm	1120	1380
		G"	1"	1"
	ErP-Klasse ErP class Classe ErP Classe ErP		B	B
	Gewicht Weight Poids Peso	kg	101	125
	Art.Nr. Part no. Réf. Art.n.		0500	0600
	Elektroheizung zum Einschrauben* Screw-in Immersion heater* Résistances à visser* Resistenza elettrica da avvitare*	bis kW to à a	6,0	7,5

*Einbaumöglichkeit: 1 x Elektroheizung zum Einschrauben
Installation option: 1 x Screw-in Immersion heater | Option d'installation: 1 x Résistances à visser | Opzione di installazione: 1 x Resistenza elettrica da avvitare