

Kombispeicher
Combination storage tanks
Ballon mixte
Serbatoi di accumulo combinati
PBNRR/E 600 – 1500

Emailliert
 Enamelled | Émaillés | Smaltato

DIN

EN 12897
EnEV 730.02
ErP 812/2013
ErP 814/2013
DIN 4753

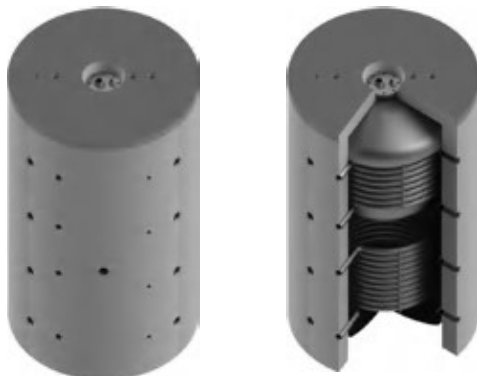

Bauart
Design | Structure | Struttura

Die Speicher werden aus hochwertigem Stahl nach EN 10025:2019 gefertigt.
 Die Speicher werden nach EN 12897:2020 dimensioniert, gefertigt und zertifiziert.

EN The storage tanks are made from high quality steel in accordance with EN 10025:2019.
 The storage tanks are designed, manufactured and certified in accordance with EN 12897:2020.

FR Les ballons sont fabriqués en acier de grande qualité selon la norme EN 10025:2019.
 Les ballons sont dimensionnés, fabriqués et certifiés selon la norme EN 12897:2020.

IT Gli accumulatori sono realizzati in acciaio pregiato secondo la norma EN 10025:2019.
 Gli accumulatori sono dimensionati, costruiti e certificati secondo la norma EN 12897:2020.

Trinkwasserspeicher Domestic hot water tank Ballon eau chaud sanitaire Bollitore acqua calda sanitaria	
Betriebsdruck / Prüfdruck Operating pressure / test pressure Pression de service / Pression test Pressione d'esercizio / Pressione di collaudo	6 bar / 12 bar
Einsatzgebiet Application Application Applicazione	max. 95°C ≥ 6°dH ≥ 11°FH
Pufferspeicher Buffer storage tanks Ballon tampon Accumulatori tampone	
Betriebsdruck / Prüfdruck Operating pressure / test pressure Pression de service / Pression test Pressione d'esercizio / Pressione di collaudo	3 bar / 4.5 bar
Einsatzgebiet Application Application Applicazione	18°C – 95°C

Lieferumfang
Delivery | Livraison | Consegna

	Dimension Dimension Dimensione	Art.Nr.	600	800	1000	1500
Thermometer (Messing Thermometer (Brass) Thermomètre (Laiton) Termometro (Ottone)	100 mm	6001150100	1x	1x	1x	1x
Tauchhülse (Messing) Thermowell (Brass) Doigt de gant (Laiton) Sonda a immersione (Ottone)	500 mm	6001180500	1x	1x	1x	1x
Magnesium Schutzanode Magne- sium protection anode Anode de protection en magnésium Anodo protettivo di magnesio	520 mm	6001140520	1x	1x	1x	1x



Schutz vor Korrosion

Anti-corrosion protection | Protection contre la corrosion | Protezione anticorrosiva

Emallierung nach DIN 4753. Magnesium Schutzanode nach DIN 4753-3. Die Pufferspeicher sind innen unbehandelt. Speicher mit separater Isolierung sind aussen grundiert.

EN Enamelling in accordance with DIN 4753. Magnesium protection anode in accordance with DIN 4753-3. The storage tanks are untreated on the interior. Tanks with separate insulation are primed on the outside.

FR Émaillage conforme à la norme DIN 4753. Anode de protection en magnésium conforme à la norme DIN 4753-3. À l'intérieur, les réservoirs ne sont pas traités. Les réservoirs avec isolation séparée sont apprêtés à l'extérieur.

IT Smaltatura secondo DIN 4753. Anodo protettivo di magnesio secondo DIN 4753-3. L'interno degli accumulatori non è trattato. Gli accumulatori con isolamento separato vengono primerizzati all'esterno.

Wärmetauscher

Heat exchanger | Échangeur de chaleur | Scambiatore di calore

Die Oberfläche des Trinkwasserspeichers dient als Wärmetauscher. Zwei eingeschweisste grossflächige Wärmetauscher.

EN The surface of the domestic hot water storage tank acts as a heat exchanger. Two welded large-surface heat exchangers.

FR La surface du ballon d'eau sanitaire placé à l'intérieur fait office d'échangeur de chaleur. Deux échangeurs de chaleur grande surface soudés.

IT La superficie dell'accumulatore d'acqua potabile funge da scambiatore di calore. Due scambiatori di calore di grande superficie saldati.

Betriebsdruck / Prüfdruck Operating pressure / test pressure Pression de service / Pression test Pressione d'esercizio / Pressione di collaudo	6 bar / 12 bar
Einsatzgebiet Application Application Applicazione	max. 110°C

Isolierung

Insulation | Isolation | Isolamento

TopShell

Isolierung aus Hightech Faservlies. Skaimantel mit Reissverschluss, inklusive Rosetten und Abdeckhaube. Brandschutzklasse B2. Silber. Lose geliefert.

Variante

Isolierung aus Hightech Faservlies. PS-Mantel und Hakenleiste, inklusive Rosetten und Abdeckhaube. Brandschutzklasse B2. Farbe Silber.

TopShell
B2; $\lambda = 0.038 \text{ W/(mK)}$

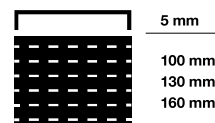

EN TopShell

Insulation made of high-tech fibre fleece. Skai jacket with zip, including cover plates and hood. Fire-resistance rating B2. Silver. Supplied loose.

FR TopShell

Isolation en tissu fibreux high-tech Enveloppe en skai avec fermeture à glissière, y compris rosettes et capot. Classe allemande de protection incendie B2. Argent. Livrée non montée.

IT TopShell

Isolamento in tessuto non tessuto high-tech. Mantello in skai pre-assemblato con cerniera, dotato di rosette e calotta di copertura. Classe di resistenza antincendio B2. Argento. Consegna sfusa.

Alternative

Insulation made of high-tech fibre fleece, PS jacket and hook rack, including cover plates and hood. Fire-resistance rating B2. Silver.

Alternative

Isolation en tissu fibreux high-tech Enveloppe en PS équipée d'un support à crochets préinstallé, y compris rosettes et capot. Classe allemande de protection incendie B2. Couleur argent.

Alternativa

Isolamento in tessuto non tessuto high-tech. Mantello in PS e barra con ganci, rosette e calotta di copertura incluse. Classe di resistenza antincendio B2. Colore argento.

Kombispeicher
Combination storage tanks
Ballon mixte
Serbatoi di accumulo combinati
PBNRR/E 600 – 1500

Emailliert
 Enamelled | Émaillés | Smaltato

Verwendung Usage Utilisation Uso		600	800	1000	1250	1500		
TopShell 100	Wärmeverlust Heat losses Pertesthermiques Perdita di calore	kWh/24h	2.89	3.12	3.38	3.82	-	
		W	121	130	141	160	-	
	ErP-Label ErP class Classe ErP Classe ErP	C	C	C	C	-		
	CH SIA 384/1 Ta ≤ 90°C	•	•	•	•	X		
	EU Nr. 814/2013 (EU)	•	•	•	•	X		
	A \downarrow [mm]	1700	1740	2090	2060	2200		
	C Ø [mm]	900	990	990	1150	1200		
	Art. Nr. 300112... Part no. Réf. Art.n.	0601	0801	1001	1251	1501*		
	TopShell 130	Wärmeverlust Heat losses Pertesthermiques Perdita di calore	kWh/24h	-	-	-	-	4.00
			W					167
ErP-Label ErP class Classe ErP Classe ErP		-	-	-	-	C		
CH SIA 384/1 Ta ≤ 90°C		•	•	•	•	•		
EU Nr. 814/2013 (EU)		•	•	•	•	•		
A \downarrow [mm]		1730	1770	2120	2090	2230		
C Ø [mm]		960	1050	1050	1210	1260		
Art. Nr. 300112... Part no. Réf. Art.n.		0602*	0802*	1002*	1252*	1502		
TopShell 160		Wärmeverlust Heat losses Pertesthermiques Perdita di calore	kWh/24h	-	-	-	-	-
			W	-	-	-	-	-
	ErP-Label ErP class Classe ErP Classe ErP	-	-	-	-	-		
	CH SIA 384/1 Ta ≤ 90°C	•	•	•	•	•		
	EU Nr. 814/2013 (EU)	•	•	•	•	•		
	A \downarrow [mm]	1760	1800	2150	2120	2260		
	C Ø [mm]	1020	1110	1110	1270	1320		
	Art. Nr. 300112... Part no. Réf. Art.n.	0603*	0803*	1003*	1253*	1503*		

Ta = Auslegungstemperatur

Ta = dimensioning temperature | Ta = température de conception | Ta = temperatura di progetto

* Keine Lagerware. Lieferzeit 4–6 Wochen

Not in stock. | Marchandise non stockée. | Merce non a magazzino.

Nicht zugelassen | None approved | Non agréée | Non omologato

Zugelassen (Empfohlene Isolierung)
Approved (Recommended insulation) | Agréée (Isolation recommandée) | Omologato (Isolamento consigliato)

Zugelassen (oberhalb Mindestanforderung)
Approved (Exceeds minimum requirements) | Agréée (Supérieure aux exigences minimales requises) | Omologato (Requisito minimo superiore)

Kombispeicher
Combination storage tanks
Ballon mixte
Serbatoi di accumulo combinati
PBNRR/E 600 – 1500

Emailliert
Enamelled | Émaillés | Smaltato

Typ PBNRR/E		600	800	1000	1500
Inhalt Heizwasser Hot water capacity Contenance de l'eau de chauffage Contenuto acqua calda	l	381	478	632	1200
Inhalt Brauchwasser Service water capacity Contenance de l'eau sanitaire Contenuto acqua per uso domestico	l	150	204	204	247
Höhe ohne Isolierung Height without insulation Hauteur sans isolation Altezza senza isolamento	mm	1670	1705	2060	2175
Ø ohne Isolierung without insulation sans isolation senza isolamento	mm	700	790	790	1000
Kippmass Tilted dimension Cote de basculement Altezza in raddrizzamento	mm	1700	1740	2090	2210
Einbringmass Delivery dimensions Cote de mise en place Ingombro	mm	730	800	800	1000
Betriebsdruck Heizung Heating operating pressure Pression de service du chauffage Pressione d'esercizio riscaldamento	bar	3	3	3	3
Prüfdruck Heizung Heating test pressure Pression test du chauffage Pressione di collaudo riscaldamento	bar	4.5	4.5	4.5	4.5
Betriebsdruck Trinkwasserspeicher Domestic hot water tank operating pressure Pression de service de la ballon ECS Pressione d'esercizio bollitore	bar	6	6	6	6
Prüfdruck Trinkwasserspeicher Domestic hot water tank test pressure Pression test de la ballon ECS Pressione di collaudo bollitore	bar	12	12	12	12
max. Betriebstemperatur max. operating temperature Temp. de service max. Temperatura max. d'esercizio	°C	95	95	95	95
Gewicht Weight Poids Peso	kg	184	218	258	332
Art.Nr. 200203... Part no. Réf. Art.n.		0600	0800	1000	1500
Isolierung Insulation Isolation Isolamento		TopShell 100			TopShell 130
Wärmeverlust Heat losses Pertesthermiques Perdita di calore	kWh/24h	2.89	3.12	3.38	4.0
	W	121	130	141	167
ErP-Klasse ErP class Classe ErP Classe ErP		C	C	C	C
Gewicht Weight Poids Peso	kg	19	25	32	39
Art.Nr. 300112... Part no. Réf. Art.n.		0601	0801	1001	1502



Typ PBNRR/E		600		800		1000		1500	
Glattrohrwärmetauscher unten Bottom heating coil Échangeurs de chaleur bas Serpentino inferiore	m ²	1.8		2.0		3.1		3.6	
Inhalt Glattrohrwärmetauscher Heating coil capacity Contenance échangeurs de chaleur Contenuto serpentinos de chaleur	l	11.8		13.3		20.5		23.3	
Glattrohrwärmetauscher oben Top heating coil Échangeurs de chaleur haut Serpentino superiore	m ²	1.2		1.8		2.5		2.3	
Inhalt Glattrohrwärmetauscher Heating coil capacity Contenance échangeurs de chaleur Contenuto serpentinos de chaleur	l	8.1		11.8		16.2		15.1	
Puffertemperatur Buffer tank temperature Température du ballon Temperatura tampone	°C	55	80	55	80	55	80	55	80
Warmwasserdauerleistung Continuous output Régime permanent Potenza continua 10°C / 45°C / 80°C	l / h	138	354	172	443	172	443	184	473
max. Warmwasserdauerleistung max. hot water continuous output Régime permanent max. eau chaude Potenza continua max. acqua calda	kW	5.6	14.4	7.0	18.0	7.0	18.0	7.5	19.2

Kombispeicher
Combination storage tanks
Ballon mixte
Serbatoi di accumulo combinati
PBNRR/E 600 – 1500

Emailliert
Enamelled | Émaillés | Smaltato

600 – 1500

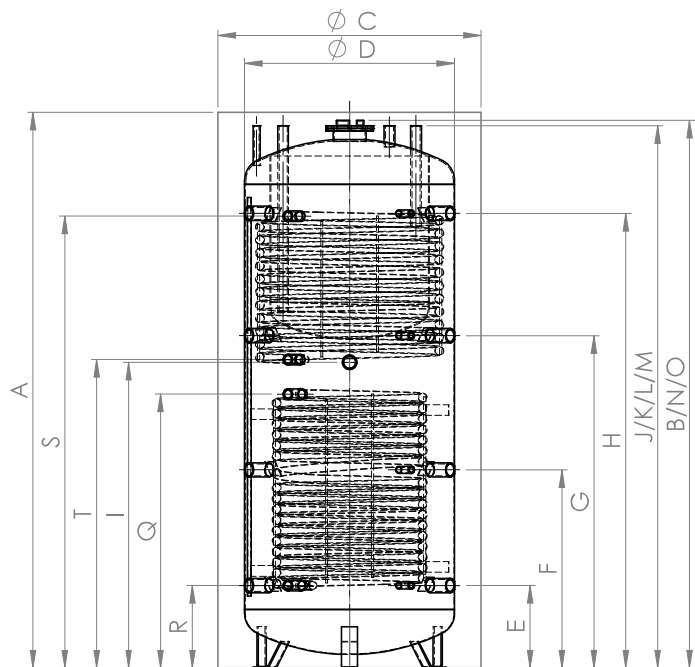



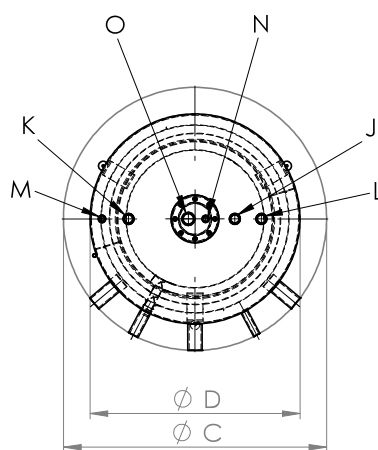















600 – 1500



600 – 1500



	Verwendung Usage Utilisation Uso	Dimension Dimension Dimension Dimensione	600	800	1000	1500
B	Höhe ohne Isolierung Height without insulation Hauteur sans isolation Altezza senza isolaento	mm	1670	1705	2060	2175
D	Ø ohne Isolierung without insulation sans isolation senza isolamento	mm	700	790	790	1000
E	Anschluss 1 Connection Raccord Collegamento	 - mm	230	260	310	380
		G"	1 ½"	1 ½"	1 ½"	2"
		 - G"	½"	½"	½"	½"
F	Anschluss 2 Connection Raccord Collegamento	 - mm	610	630	745	825
		G"	1 ½"	1 ½"	1 ½"	2"
		 - G"	½"	½"	½"	½"
G	Anschluss 3 Connection Raccord Collegamento	 - mm	990	1030	1250	1350
		G"	1 ½"	1 ½"	1 ½"	2"
		 - G"	½"	½"	½"	½"
H	Anschluss 4 Connection Raccord Collegamento	 - mm	1380	1430	1710	1760
		G"	1 ½"	1 ½"	1 ½"	2"
		 - G"	½"	½"	½"	½"
I	Anschluss Mitte / ESH Connection middle SIH Raccord milieu Collegamento centrale	 - mm	850	800	1150	1250
		G"	1 ½"	1 ½"	1 ½"	1 ½"
J	Warmwasser Hot water Eau chaude Acqua calda	 - mm	1650	1685	2040	2155
		G"	1"	1"	1"	1"
K	Kaltwasser Cold water Eau froide Acqua fredda	 - mm	1650	1685	2040	2155
		G"	1"	1"	1"	1"
L	Zirkulation Circulation Circulation Circolazione	 - mm	1650	1685	2040	2155
		G"	1"	1"	1"	1"
M	Entlüftung Vent Purge Sfiato	 - mm	1650	1685	2040	2155
		G"	½"	½"	½"	½"
N	Fühler Brauchwasser Service water sensor Sonde eau industrielle Sensore acqua per uso domestico	 - mm	1670	1705	2060	2175
		G"	½"	½"	½"	½"
O	Magnesiumanode Magnesium anode Anode de magnésium Anodo in magnesio	 - mm	1670	1705	2060	2175
		G"	1 ¼"	1 ¼"	1 ¼"	1 ¼"
Q	VL Glattrohrwärmetauscher unten Bottom heating coil Échangeurs de chaleur bas Serpentino inferiore	 - mm	790	730	1030	1180
		G"	1"	1"	1"	1"
R	RL Glattrohrwärmetauscher unten Bottom heating coil Échangeurs de chaleur bas Serpentino inferiore	 - mm	250	260	310	380
		G"	1"	1"	1"	1"
S	VL Glattrohrwärmetauscher oben Top heating coil Échangeurs de chaleur haut Serpentino superiore	 - mm	1275	1430	1700	1760
		G"	1"	1"	1"	1"
T	RL Glattrohrwärmetauscher oben Top heating coil Échangeurs de chaleur haut Serpentino superiore	 - mm	920	1070	1160	1350
		G"	1"	1"	1"	1"