

Pufferspeicher
Buffer storage tanks
Ballon tampon
Accumulatori tampone
PSM 200 – 600

EnEV 730.02
ErP 812/2013
ErP 814/2013
SIA 384/1



Bauart
Design | Structure | Struttura

Die Speicher werden aus hochwertigem Stahl nach EN 10025:2019 gefertigt.

EN The storage tanks are made from high quality steel in accordance with EN 10025:2019.

FR Les ballons sont fabriqués en acier de grande qualité, selon la norme EN 10025:2019.

IT Gli accumulatori sono realizzati in acciaio pregiato secondo la norma EN 10025:2019.

Betriebsdruck / Prüfdruck Operating pressure / test pressure Pression de service / Pression test Pressione d'esercizio / Pressione di collaudo	3 bar / 4.5 bar
Einsatzgebiet Application Application Applicazione	18°C – 95°C



Schutz vor Korrosion

Anti-corrosion protection | Protection contre la corrosion | Protezione anticorrosiva

Innen sind die Speicher unbehandelt, Aussen sind die Speicher mit PU-Schaum fix geschäumt.

EN The storage tanks are untreated on the interior. On the exterior the storage tanks are foamed with polyurethane foam.

FR À l'intérieur, les réservoirs ne sont pas traités. À l'extérieur, ils sont recouverts de mousse fixe.

IT L'interno degli accumulatori non è trattato. All'esterno gli accumulatori presentano una copertura di schiuma PU fissa.

Isolierung

Insulation | Isolation | Isolamento

PUR-Hartschaum

60 mm PUR-Hartschaum fix geschäumt. Skaimantel 5 mm mit Reissverschluss vormontiert, inklusive Rosetten und Abdeckhaube. Brandschutzklasse B2. Silber. Weitere Farben nach Absprache.

EN Rigid polyurethane foam (PUR) 60 mm rigid polyurethane foam. Skai jacket 5 mm with zip preassembled, including cover plates and hood. Fire-resistance rating B2. Silver. Other colours on request.

FR Mousse solidifiée PUR 60 mm de mousse dure PUR Enveloppe en skai de 5 mm préinstallée avec fermeture à glissière, y compris rosettes et capot. Classe allemande de protection incendie B2. Argent. Autres couleurs après concertation.

IT Schiuma PUR rigida 60 mm di schiuma rigida di poliuretano fissa. Mantello in skai da 5 mm pre-assemblato con cerniera, dotato di rosette e calotta di copertura. Classe di resistenza antincendio B2. Argento. Altri colori su richiesta.

≤ 600 L
PUR (Polyurethane)
B2; λ = 0.026 W/(mK)

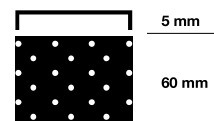

5 mm

60 mm

Pufferspeicher
Buffer storage tanks
Ballon tampon
Accumulatori tampone
PSM 200 – 600

200 – 600

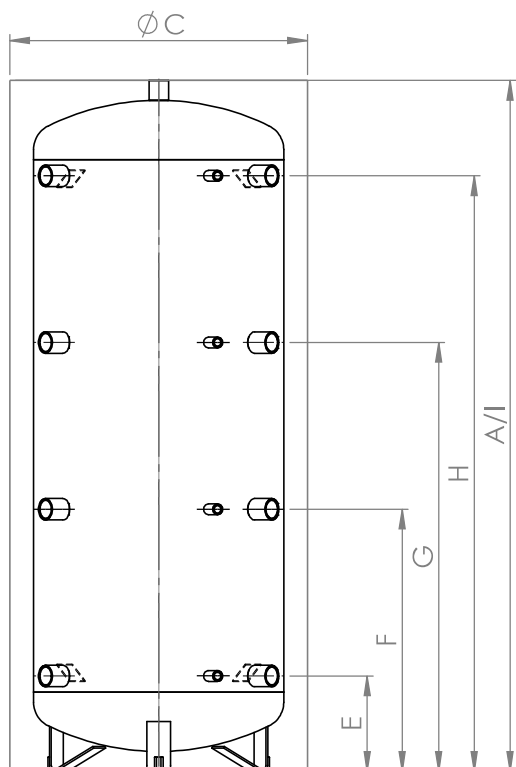



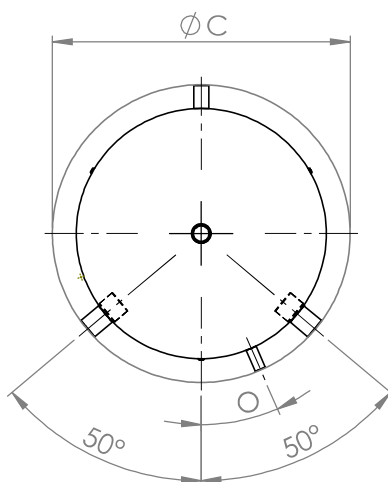





200 – 600



200 – 600

Isolierung Insulation Isolation Isolamento		60 mm fix eingeschäumt Fixed with foam Enrobage mousse fixe Schiuma rigida fissa				
Verwendung Usage Utilisation Uso	Dimension Dimension Dimension Dimensione	200	300	400	500	600
Wärmeverlust Heat losses Pertesthermiques Perdita di calore	kWh/24h	1.01	1.44	1.69	1.95	2.05
	W	43	60	71	82	86
ErP-Klasse ErP class Classe ErP Classe ErP		A	B	B	B	B
Gewicht Weight Poids Peso	kg	46	60	72	83	91
Art.Nr. Part no. Réf. Art.n.	200103...	0200	0300	0400	0500	0600
Elektroheizung zum Einschrauben* Screw-in Immersion heater* Résistances à visser* Resistenza elettrica da avvitare*	bis kW to à a	3.0	4.5	6.0	6.0	6.0

	Verwendung Usage Utilisation Uso	Dimension Dimension Dimension Dimensione	200	300	400	500	600
	Inhalt Capacity Contenance Contenuto	l	190	282	377	479	559
	Kippmass Tilted dimension Cote de basculement Altezza in raddrizzamento	mm	1360	1610	1590	1900	2140
A	Höhe mit Isolierung Height with insulation Hauteur avec isolation Altezza con isolamento	mm	1210	1470	1400	1740	2000
C	Ø mit Isolierung with insulation avec isolation con isolamento	mm	600	650	750	750	750
E*	Anschluss 1 Connection Raccord Collegamento	 - mm	215	240	240	240	240
		G"	1 1/2"	1 1/2"	1 1/2"	1 1/2"	1 1/2"
		 - G"	1/2"	1/2"	1/2"	1/2"	1/2"
F*	Anschluss 2 Connection Raccord Collegamento	 - mm	475	570	550	660	750
		G"	1 1/2"	1 1/2"	1 1/2"	1 1/2"	1 1/2"
		 - G"	1/2"	1/2"	1/2"	1/2"	1/2"
G*	Anschluss 3 Connection Raccord Collegamento	 - mm	735	900	850	1080	1250
		G"	1 1/2"	1 1/2"	1 1/2"	1 1/2"	1 1/2"
		 - G"	1/2"	1/2"	1/2"	1/2"	1/2"
H*	Anschluss 4 Connection Raccord Collegamento	 - mm	665	1230	1160	1500	1760
		G"	1 1/2"	1 1/2"	1 1/2"	1 1/2"	1 1/2"
		 - G"	1/2"	1/2"	1/2"	1/2"	1/2"
I	Anschluss oben Connection above Raccord du haut Collegamento superiore	 - mm	1210	1470	1400	1740	2000
		G"	1 1/4"	1 1/4"	1 1/4"	1 1/4"	1 1/4"
O	Anordnung Fühler Positioning sensor Disposition sonde Disposizione sensore	°	15.0	18.5	23.5	23.5	23.5

*Einbaumöglichkeit: 1 x Elektroheizung zum Einschrauben
Installation option: 1 x Screw-in Immersion heater | Option d'installation: 1 x Résistances à visser | Opzione di installazione: 1 x Resistenza elettrica da avvitare