

**Pufferspeicher für Wärmepumpe**  
**Buffer storage tanks for heat pump**  
**Ballon tampon pour pompe à chaleur**  
**Accumulatori tampone per pompa di calore**  
**PU 200 – 600**

**EnEV 730.02**  
**ErP 812/2013**  
**ErP 814/2013**  
**SIA 384/1**  
**CE**



**Bauart**  
**Design | Structure | Struttura**

Die Speicher werden aus hochwertigem Stahl nach EN 10025:2019 gefertigt.

**EN** The storage tanks are made from high quality steel in accordance with EN 10025:2019.

**FR** Les ballons sont fabriqués en acier de grande qualité, selon la norme EN 10025:2019.

**IT** Gli accumulatori sono realizzati in acciaio pregiato secondo la norma EN 10025:2019.

<b>Betriebsdruck / Prüfdruck</b> Operating pressure / test pressure   Pression de service / Pression test   Pressione d'esercizio / Pressione di collaudo	3 bar / 4.5 bar
<b>Einsatzgebiet</b> Application   Application   Applicazione	18°C – 95°C



### Schutz vor Korrosion

Anti-corrosion protection | Protection contre la corrosion | Protezione anticorrosiva

Innen sind die Speicher unbehandelt, Aussen sind die Speicher mit PU-Schaum fix geschäumt.

**EN** The storage tanks are untreated on the interior. On the exterior the storage tanks are foamed with polyurethane foam.

**FR** À l'intérieur, les réservoirs ne sont pas traités. À l'extérieur, ils sont recouverts de mousse fixe.

**IT** L'interno degli accumulatori non è trattato. All'esterno gli accumulatori presentano una copertura di schiuma PU fissa.

### Isolierung

Insulation | Isolation | Isolamento

#### PUR-Hartschaum

60 mm PUR-Hartschaum fix geschäumt. Skaimantel 5 mm mit Reissverschluss vormontiert, inklusive Rosetten und Abdeckhaube. Brandschutzklasse B2. Silber. Weitere Farben nach Absprache.

**EN** Rigid polyurethane foam (PUR) 60 mm rigid polyurethane foam. Skai jacket 5 mm with zip preassembled, including cover plates and hood. Fire-resistance rating B2. Silver. Other colours on request.

**FR** Mousse solidifiée PUR 60 mm de mousse dure PUR Enveloppe en skai de 5 mm préinstallée avec fermeture à glissière, y compris rosettes et capot. Classe allemande de protection incendie B2. Argent. Autres couleurs après concertation.

**IT** Schiuma PUR rigida 60 mm di schiuma rigida di poliuretano fissa. Mantello in skai da 5 mm pre-assemblato con cerniera, dotato di rosette e calotta di copertura. Classe di resistenza antincendio B2. Argento. Altri colori su richiesta.

≤ 600 L  
PUR (Polyurethane)  
B2; λ = 0.026 W/(mK)

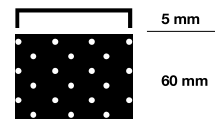

**Pufferspeicher für Wärmepumpe**  
**Buffer storage tanks for heat pump**  
**Ballon tampon pour pompe à chaleur**  
**Accumulatori tampone per pompa di calore**  
**PU 200 – 600**



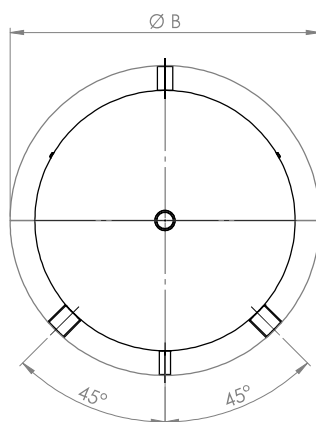
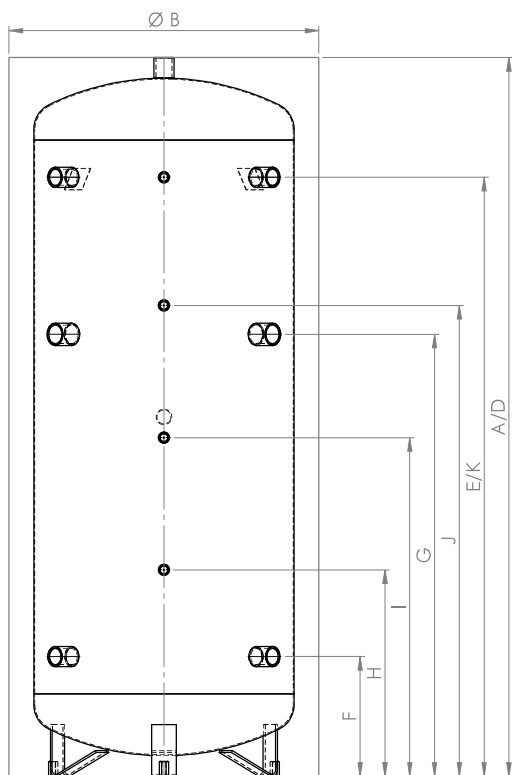





200 – 600



200 – 600

200 – 600

Isolierung Insulation   Isolation   Isolamento		60 mm fix eingeschäumt Fixed with foam   Enrobage mousse fixe   Schiuma rigida fissa				
Verwendung Usage Utilisation Uso	Dimension Dimension Dimension Dimensione	200	300	400	500	600
Wärmeverlust Heat losses   Pertesthermiques   Perdita di calore	kWh/24h	1.01	1.44	1.69	1.95	2.05
	W	43	60	71	82	86
ErP-Klasse ErP class   Classe ErP   Classe ErP		A	B	B	B	B
Gewicht Weight   Poids   Peso	kg	46	61	70	80	91
Art.Nr. Part no.   Réf.   Art.n.	200101...	0200	0300	0400	0500	0600

	Verwendung Usage Utilisation Uso	Dimension Dimension Dimension Dimensione	200	300	400	500	600
	Inhalt Capacity   Contenance   Contenuto	l	190	282	377	479	559
	Kippmass Tilted dimension   Cote de basculement   Altezza in raddrizzamento	mm	1360	1610	1590	1900	2140
A	Höhe mit Isolierung Height with insulation   Hauteur avec isolation   Altezza con isolamento	mm	1210	1470	1400	1740	2000
B	Ø mit Isolierung with insulation   avec isolation   con isolamento	mm	600	650	750	750	750
D	Vorlauf Supply   Alimentation   Mandata	 - mm	1210	1470	1400	1740	2000
		G"	1 ¼"	1 ¼"	1 ¼"	1 ¼"	1 ¼"
E	Vorlauf Supply   Alimentation   Mandata	 - mm	995	1245	1160	1450	1760
		G"	1 ¼"	1 ¼"	1 ¼"	1 ¼"	1 ¼"
F	Rücklauf Return   Retour   Ritorno	 - mm	215	225	240	290	240
		G"	1 ¼"	1 ¼"	1 ¼"	1 ¼"	1 ¼"
G	Elektroheizung zum Einschrauben* Screw-in Immersion heater*   Résistances à visser*   Resistenza elettrica da avvitare*	 - mm	735	900	870	1070	1270
		G"	1 ½"	1 ½"	1 ½"	1 ½"	1 ½"
H	Thermometer / Fühler Thermometer / Sensor   Thermomètre / Sonde   Termometro / Sensore	 - mm	425	465	470	500	470
		G"	½"	½"	½"	½"	½"
I	Thermometer / Fühler Thermometer / Sensor   Thermomètre / Sonde   Termometro / Sensore	 - mm	615	725	700	820	900
		G"	½"	½"	½"	½"	½"
J	Thermometer / Fühler Thermometer / Sensor   Thermomètre / Sonde   Termometro / Sensore	 - mm	805	985	930	1140	1330
		G"	½"	½"	½"	½"	½"
K	Thermometer / Fühler Thermometer / Sensor   Thermomètre / Sonde   Termometro / Sensore	 - mm	995	1245	1160	1450	1760
		G"	½"	½"	½"	½"	½"

\*Einbaumöglichkeit: 1 x Elektroheizung zum Einschrauben  
Installation option: 1 x Screw-in Immersion heater | Option d'installation: 1 x Résistances à visser | Opzione di installazione: 1 x Resistenza elettrica da avvitare