

Kältepufferspeicher
Buffer tank for cold water
Ballon tampon pour eau froide
Accumulatori di freddo
PUFK 200 – 600

EnEV 730.02
ErP 812/2013
ErP 814/2013
CE

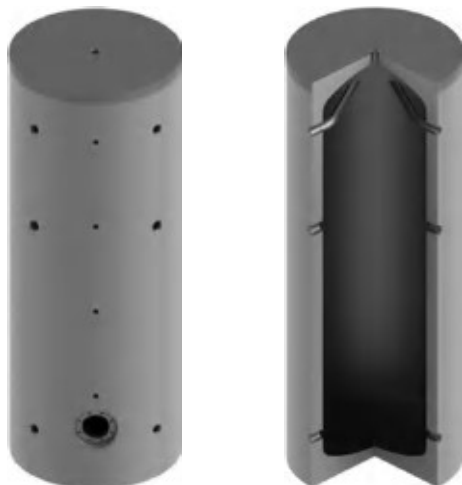

Bauart
Design | Structure | Struttura

Die Speicher werden aus hochwertigem Stahl nach EN 10025:2019 gefertigt.

EN The storage tanks are made from high quality steel in accordance with EN 10025:2019.

FR Les ballons sont fabriqués en acier de grande qualité, selon la norme EN 10025:2019.

IT Gli accumulatori sono realizzati in acciaio pregiato secondo la norma EN 10025:2019.

Betriebsdruck / Prüfdruck Operating pressure / test pressure Pression de service / Pression test Pressione d'esercizio / Pressione di collaudo	3 bar / 4.5 bar 6 bar / 9 bar
Einsatzgebiet Application Application Applicazione	10°C – 95°C



Schutz vor Korrosion

Anti-corrosion protection | Protection contre la corrosion | Protezione anticorrosiva

Innen sind die Speicher unbehandelt. Aussen sind die Speicher mit einer PEXL Isolierung verklebt, darüber mit PUR-Hartschaum direkt fix geschäumt. Die diffusionsdichte PEXL Isolierung schützt vor Schwitzwasser. Der Taupunkt der Lufttemperatur muss beachtet werden.

EN The storage tanks are untreated on the interior. On the exterior the storage tanks are taped with PEXL insulation and foamed directly on top with rigid polyurethane foam. The impermeable PEXL insulation protects against condensation. The dew point of the ambient air temperature must be observed.

FR À l'intérieur, les réservoirs ne sont pas traités. À l'extérieur, les réservoirs sont enduits d'une couche isolante PEXL fixée à la colle, et moussés par dessus avec la mousse dure PUR. L'isolation PEXL étanche à la diffusion protège contre les eaux de condensation. Le point de condensation de la température ambiante doit être respecté.

IT L'interno degli accumulatori non è trattato. All'esterno gli accumulatori presentano un isolamento PEXL incollato, sopra il quale viene applicata direttamente la schiuma poliuretanic rigida. L'isolamento antidiffusione PEXL protegge dall'acqua di trasudamento. Il punto di rugiada della temperatura ambiente deve essere rispettato.

Isolierung

Insulation | Isolation | Isolamento

PU-Hartschaum + Kälteisolation

20 mm PEXL Isolierung verklebt + 30 mm PU-Hartschaum fix geschäumt, Skaimantel 5 mm mit Reissverschluss vormontiert, inklusive Rosetten und Abdeckhaube. Brandschutzklasse B2. Silber. Weitere Farben nach Absprache.

Empfehlung: Einsatz bei Temperaturen >10°C und <18°C. Verhindert Bildung von Schwitzwasser. Die angegebenen Einsatzbereiche verstehen sich als Empfehlung und ersetzen keine Auslegung nach den vor Ort vorherrschenden Bedingungen.

PU-Hartschaum + PEXL
B2; λ = 0,026 W/(mK)
B1; λ = 0,038 W/(mK)

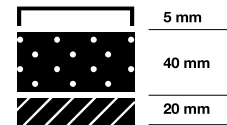

EN Rigid polyurethane foam + cooling insulation

20 mm taped PEXL insulation + 30 mm quick-foam rigid polyurethane foam. Skai jacket 5 mm with preassembled zip, including cover plates and hood. Fire-resistance rating B2. Silver.

FR Mousse dure PU + isolation contre le froid

Isolation PEXL de 20 mm collée + 30 mm de mousse dure PU. Enveloppe en skaï de 5 mm avec fermeture à glissière préinstallée, y compris rosettes et capot. Classe allemande de protection incendie B2. Argent.

IT Schiuma PU rigida + isolamento termico

20 mm di isolamento PEXL incollato + 30 mm di schiuma PU rigida fissa. Mantello in skai da 5 mm pre-assemblato con cerniera, dotato di rosette e calotta di copertura. Classe di resistenza antincendio B2. Argent.

Recommendation: For application at temperatures of >10°C and <18°C. Prevents formation of condensation. The specified application ranges are to be understood as recommendations and do not replace any design according to the on-site conditions prevailing.

Recommandation: Mise en œuvre à des températures >10°C et <18°C. Empêche la formation d'eaux de condensation. Les domaines d'utilisation indiqués s'entendent comme des recommandations et ne remplacent pas une interprétation selon les conditions prévalant sur place.

Consiglio: impiego a temperature >10°C e <18°C. Impedisce la formazione di acqua di trasudamento. I campi di applicazione specificati devono essere intesi come raccomandazioni e non sostituiscono una progettazione in base alle condizioni prevalenti in loco.

T _L °C	maximale relative Feuchte Maximum relative humidity humidité relative maximum Umidità relativa massima %		
	T _s 10 °C	T _s 15 °C	T _s 18 °C
10	90	90	90
15	75	90	90
20	60	75	85
25	45	60	70
30	35	45	55

T_L
Lufttemperatur
Ambient air temperature |
Température ambiante |
Temperatura ambiente

T_s
Speichertemperatur
storage temperatur |
Température du ballon |
Temperatura di accumulo





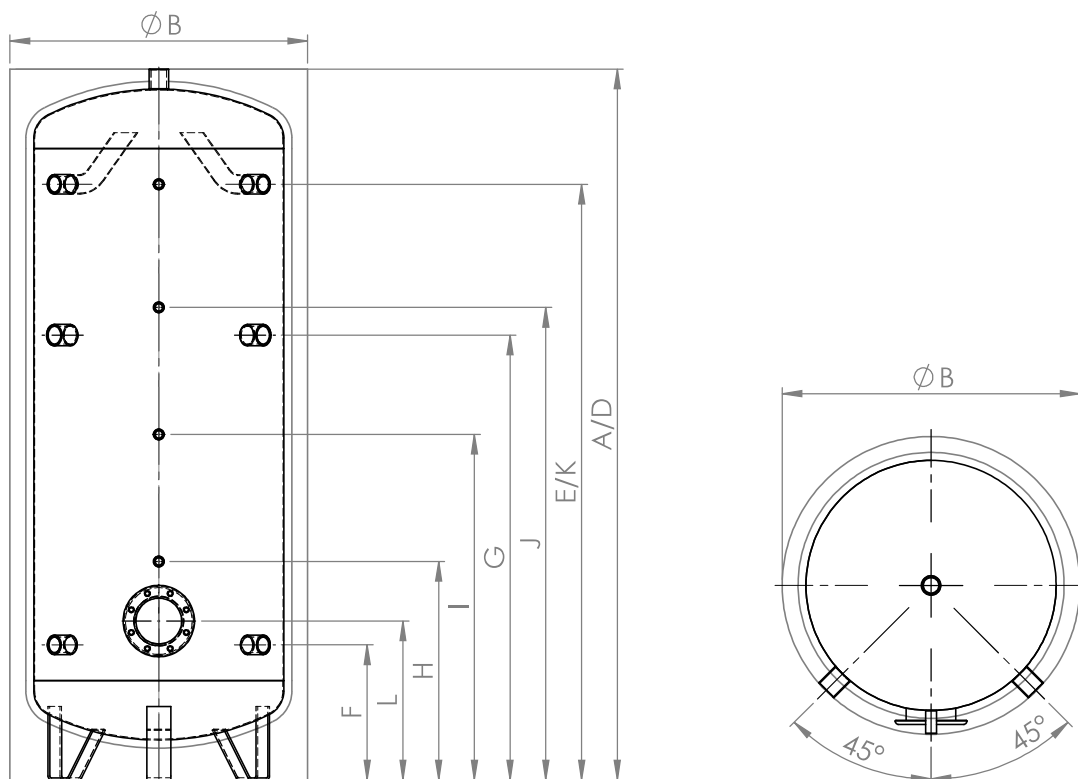



Kältepufferspeicher
Buffer tank for cold water
Ballon tampon pour eau froide
Accumulatori di freddo
PUFK 200 – 600

200 – 600



Isolierung Insulation Isolation Isolamento		20 mm PEXL + 40 mm fix eingeschäumt 20 mm PEXL + 40 mm rigid polyurethane foam 20 mm PEXL + 40 mm de mousse dure PU 20 mm PEXL + 40 mm di schiuma PU rigida				
Verwendung Usage Utilisation Uso	Dimension Dimension Dimension Dimensione	200	300	400	500	600
Wärmeverlust Standby heat losses Pertesthermiques Perdita di calore in stand-by	kWh/24h	1.01	1.44	1.69	1.95	2.05
	W	43	60	71	82	86
ErP-Klasse ErP class Classe ErP Classe ErP		A	B	B	B	B
Gewicht Weight Poids Peso	kg	46	61	70	80	91
Art.Nr. Part no. Réf. Art.n.	200902... 3 bar / 4.5 bar	0200	0300	0400	0500	0600
Art.Nr. Part no. Réf. Art.n.	200902... 6 bar / 9 bar	9200	9300	9400	9500	9600



	Verwendung Usage Utilisation Uso	Dimension Dimension Dimension Dimensione	200	300	400	500	600
	Inhalt Capacity Contenance Contenuto	l	190	282	377	479	559
	Kippmass Tilted dimension Cote de basculement Altezza in raddrizzamento	mm	1360	1610	1590	1900	2140
A	Höhe mit Isolierung Height with insulation Hauteur avec isolation Altezza con isolamento	mm	1210	1470	1400	1740	2000
B	Ø mit Isolierung with insulation avec isolation con isolamento	mm	600	650	750	750	750
D	Vorlauf Supply Alimentation Mandata	 - mm	1210	1470	1400	1740	2000
		G"	1 ¼"	1 ¼"	1 ¼"	1 ¼"	1 ¼"
E	Vorlauf Supply Alimentation Mandata	 - mm	995	1245	1160	1450	1760
		G"	1 ¼"	1 ¼"	1 ¼"	1 ¼"	1 ¼"
F	Rücklauf Return Retour Ritorno	 - mm	215	225	240	290	240
		G"	1 ¼"	1 ¼"	1 ¼"	1 ¼"	1 ¼"
G	Elektroheizung zum Einschrauben* Screw-in Immersion heater* Résistances à visser* Resistenza elettrica da avvitare*	 - mm	735	900	870	1070	1270
		G"	1 ½"	1 ½"	1 ½"	1 ½"	1 ½"
H	Thermometer / Fühler Thermometer / Sensor Thermomètre / Capteur Termometro / Sensor	 - mm	425	465	470	500	470
		G"	½"	½"	½"	½"	½"
I	Thermometer / Fühler Thermometer / Sensor Thermomètre / Capteur Termometro / Sensor	 - mm	615	725	700	820	900
		G"	½"	½"	½"	½"	½"
J	Thermometer / Fühler Thermometer / Sensor Thermomètre / Capteur Termometro / Sensor	 - mm	805	985	930	1140	1330
		G"	½"	½"	½"	½"	½"
K	Thermometer / Fühler Thermometer / Sensor Thermomètre / Capteur Termometro / Sensor	 - mm	995	1245	1160	1450	1760
		G"	½"	½"	½"	½"	½"
L	Flansch Flange Bride Flangia	 - mm	285	290	300	300	300
		Ø - mm	180/120	180/120	180/120	180/120	180/120

*Einbaumöglichkeit: 1 x Elektroheizung zum Einschrauben
Installation option: 1 x Screw-in Immersion heater | Option d'installation: 1 x Résistances à visser | Opzione di installazione: 1 x Resistenza elettrica da avvitare